

# D i s h w a s h e r

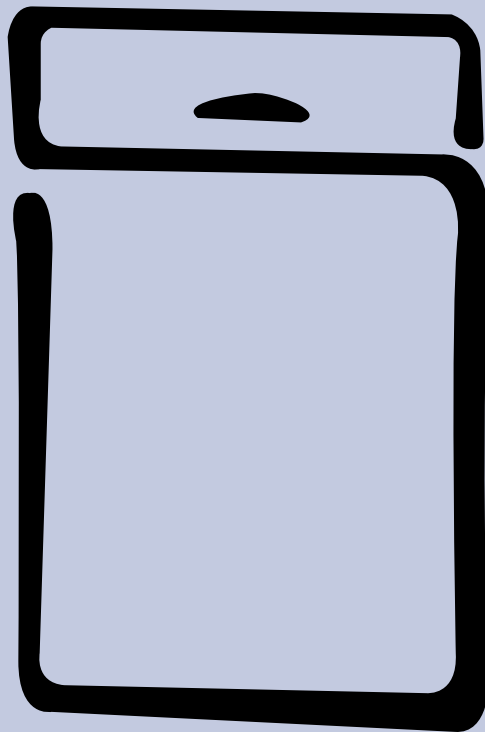

*Model ESL 4114*

**UK**

**Instruction book**

# Description of the appliance

1. Water hardness adjustment
2. Upper basket stop
3. Lower spray arm
4. Salt container
5. Detergent dispenser
6. Rinse aid dispenser
7. Control panel
8. Filters
9. Upper spray arm
10. Upper basket
11. Levelling spacers

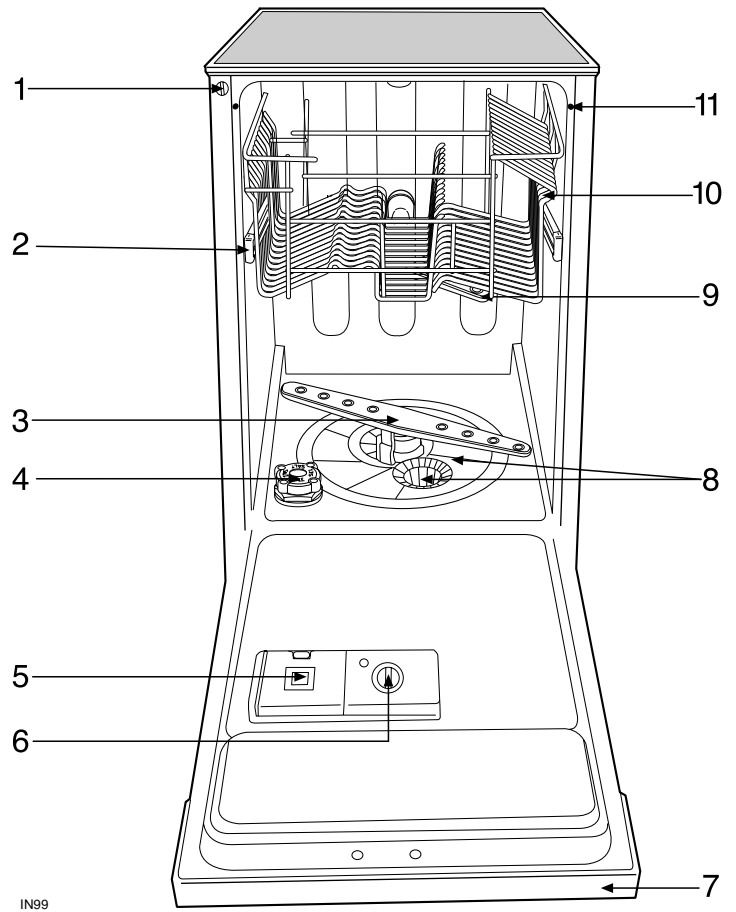



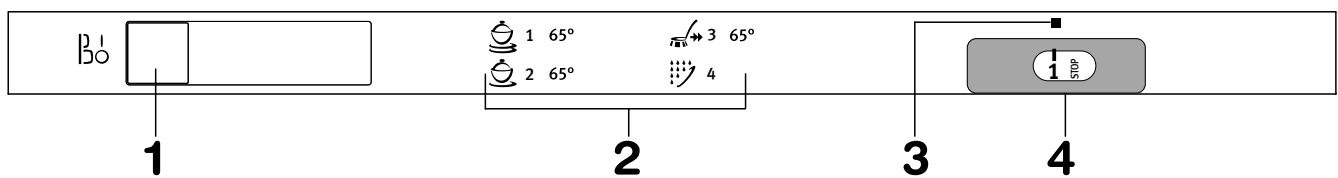

## The control panel



1. On/Off push button
2. Programme guide

3. Programme marker
4. Programme selector dial

# Washing programmes

Programme	Degree of soil and type of load	Starting position of the programme selector	Required push button	Recommended quantity of detergent		Cycle description
				wash	prewash	
 * 1 65°	Heavy soil. Crockery, cutlery, pots and pans	1	On/Off	20 g	5 g	Cold prewash Main wash up to 65°C 1 cold rinse 1 hot rinse Drying
 2 65°	Normal soil. Crockery and cutlery	2	On/Off	25 g	/	Main wash up to 65°C 1 cold rinse 1 hot rinse Drying
 ** 3 65°	Light soil. Crockery and party crockery	3	On/Off	25 g	/	Main wash up to 65°C 1 cold rinse 1 hot rinse
 4	Any. Partial load (to be completed later in the day).	4	On/Off	/	/	1 cold rinse (to avoid food scraps from sticking together).

\* Testing programme for EN 50242 (see "Hints for Test Centres").

\*\* This is a special programme for quick washing a full load of lightly soiled dishes, glasses and crockery (except pots) so that you may re-use them promptly.

## Technical specifications

Dimensions	Width	44.6 cm
	Height	81.8 - 87.8 cm
	Max depth	55.5 cm
	Max depth with open door	111.4 cm
Electrical connection	Voltage	220/240 V - 50 Hz
	Motor rating during wash	200 W
	Power of heating element	1900 W
	Overall power	2100 W
Water supply pressure	Minimum	50 kPa (0.5 bar)
	Maximum	800 kPa (8 bar)
Capacity		8 place settings

# Operating sequence

## 1. Check the filters

Ensure they are clean and properly positioned (see "Maintenance and cleaning"- Instruction book part 1).

## 2. Check that there is rinse aid and salt

## 3. Load the dishes

Remove any scraps of food.

Pull the lower basket out and arrange the saucepans, plates and cutlery in it.

Pull the upper basket out and arrange the plates, saucers, glasses and cups etc. in it.

Slide the baskets back into the machine.

## 4. Ensure that the spray arms can rotate freely.

## 5. Measure out detergent

Add the required amount of detergent into the dispenser according to the dosage quantity given in the "Washing programmes" chart.

Close the detergent dispenser lid.

## 6. Set the programme

The selection of a programme occurs with the door partially opened.

Turn the programme selector dial clockwise until the number of the programme you wish to select corresponds with the programme marker on the control panel.

## 9. Start the programme

Depress the On/Off push button and close the door, the machine will start.

If you wish to interrupt the washing programme at any time open the door and press this button again.

## 10. At the end of the washing programme

At the end of the programme the dishwasher will automatically stop.

## 11. Switch off the dishwasher

Switch off the dishwasher by opening the door and pressing the On/Off push button.

Wait a few minutes before removing the dishes; in this way they will be cooler and the drying will be improved.

Empty the lower basket first and then the upper one; this will avoid water dripping from the upper basket onto the dishes in the lower one.

**When the washing programme has finished, it is recommended that the dishwasher is unplugged and the water tap turned off.**

**In general it is not advisable to open the door while the machine is working; if the door is opened however, a safety device ensures that the machine stops.**

**Important!**

**Care must be taken if the door is opened during the hot phase or immediately after a programme has finished, as steam may escape.**

# Using your appliance

## Loading your appliance

Before placing dishes in the machine, remove any scraps of food, to avoid clogging the filters and consequently reducing the performance.

**Do not load very small items which can fall through the baskets.**

Open the door and slide out the baskets to load the dishes.

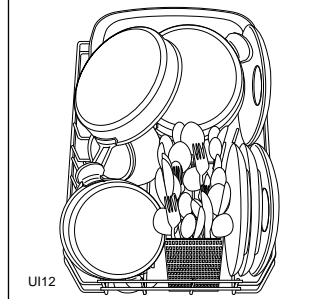
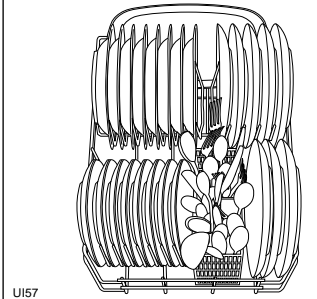

## The lower basket

The lower basket is designed to take saucepans, lids, plates, salad bowls, cutlery etc.

Serving dishes and large lids should be arranged around the edge of the basket, ensuring that the upper spray arm can turn freely.

## The cutlery basket

**Long bladed knives stored in an upright position are a potential hazard.**

**Long and/or sharp items of cutlery such as carving knives must be positioned horizontally in the upper basket.**

**Take care when loading or unloading sharp items such as knives.**

Cutlery should be placed in the removable cutlery basket with the handles facing downwards.

If the handles protrude from the bottom of the basket, obstructing the lower spray arm, load the cutlery with the handles facing upwards.

Mix spoons with other cutlery to prevent them from sticking together.

Silver cutlery tends to go black if mixed with steel cutlery. Place it in the cutlery basket separate from the others.

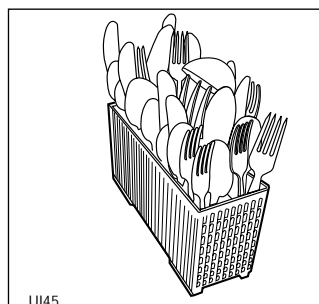

## The upper basket

The upper basket is designed for plates (dessert plates, saucers, dinner plates of up to 24 cm in diameter), salad bowls, cups and glasses.

Arrange items on and underneath the cup rack so that water can reach all surfaces.

Glasses with long stems can be placed upside down in the cup rack.

Light items (plastic bowls etc.) should be loaded in the upper basket and arranged so they do not move.

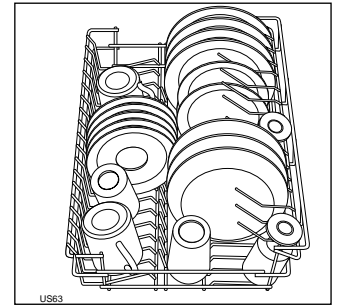

**Before closing the door, ensure that the spray arms can rotate freely.**

## Adjusting the height of the upper basket

If washing very large plates (over 27 cm and up to 31 cm in diameter) you can load them in the lower basket after moving the upper basket to the higher position.

**To move to the higher position proceed as follows:**

1. Move the front runner stops (A) of the upper basket outward and slide the basket out.
2. Refit the basket in the higher position and replace the stops (A) in their original position.

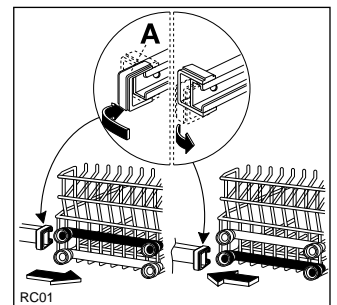

**When the top basket is in the higher position it will only take plates up to 20 cm in diameter and you will not be able to use the cup rack.**

**After loading your machine always close the door, as an open door can be a hazard.**

# Hints for test centres

Before starting any test it is necessary to fill completely with salt the salt container and with rinse aid the rinse aid dispenser.

Test standard	EN 50242
Reference programme:	Power Wash 65°C
Load:	8 standard place settings
Rinse aid selector:	position 4
Detergent dosage :	20 g in the dispenser 5 g on the dispenser lid



Arrangement upper basket



Arrangement  
cutlery basket

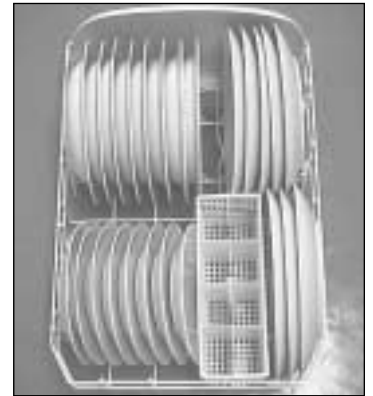

Arrangement lower basket

# Service and Spare Parts

In the event of your appliance requiring service, or if you wish to purchase spare parts please contact your local Service Force Centre by telephoning:

**08705 929929**

Your telephone call will be automatically routed to the Service Force centre covering your post code area.

For the address of your local Service Force Centre and further information about Service Force, please visit the website at [www.serviceforce.co.uk](http://www.serviceforce.co.uk)

Before calling out an engineer, please ensure you read the details under the heading Something not working.

When you contact the Service Force Centre you will need to give the following details:

1. Your name, address and post code
2. Your telephone number
3. Clear and concise details of the fault
4. The model and serial number (found on the rating plate)
5. The purchase date

Please note that a valid purchase receipt or guarantee documentation is required for in-guarantee service calls.

## Customer Care Department

For general enquiries concerning your Electrolux appliance or for further information on Electrolux products please contact our Customer Care Department by letter or telephone at the address below or visit our website at [www.electrolux.co.uk](http://www.electrolux.co.uk)

Customer Care Department  
Electrolux  
55-77 High Street  
Slough  
Berkshire  
SL1 1DZ  
Tel: 08705 950950 (\*)

*\* calls to this number may be recorded for training purposes*

## Guarantee Conditions

### Standard guarantee conditions

We, Electrolux, undertake that if within 12 months of the date of purchase this Electrolux appliance or any part thereof is proved to be defective by reason only of faulty workmanship or materials, we will, at our option repair or replace the same FREE OF CHARGE for labour, materials or carriage on condition that:

- The appliance has been correctly installed and used only on the electricity supply stated on the rating plate.
- The appliance has been used for normal domestic purposes only, and in accordance with the manufacturer's instructions.
- The appliance has not been serviced, maintained repaired, taken apart or tampered with by any person not authorised by us.
- All service work under this guarantee must be undertaken by a Electrolux Service Force Centre.
- Any appliance or defective part replaced shall become the Company's property.
- This guarantee is in addition to your statutory and other legal rights.

Home visits are made between **8.30am** and **5.30pm** Monday to Friday. Visits may be available outside these hours in which case a premium will be charged.

## Exclusions

**This guarantee does not cover:**

- Damage or calls resulting from transportation, improper use or neglect, the replacement of any light bulbs or removable parts of glass or plastic.
- Costs incurred for calls to put right an appliance which is improperly installed or calls to appliances outside the United Kingdom.
- Appliances found to be in use within a commercial environment, plus those which are subject to rental agreements.
- Products of Electrolux manufacture which are not marketed by Electrolux.

## European Guarantee

If you should move to another country within Europe then your guarantee moves with you to your new home subject to the following qualifications:

- The guarantee starts from the date you first purchased your product.
- The guarantee is for the same period and to the same extent for labour and parts as exists in the new country of use for this brand or range of products.
- This guarantee relates to you and cannot be transferred to another user.
- Your new home is within the European Community (EC) or European free Trade Area.
- The product is installed and used in accordance with our instructions and is only used domestically, i.e. a normal household.
- The product is installed taking into account regulations in your new country.

Before you move please contact your nearest Customer Care centre, listed below, to give them details of your new home. They will then ensure that the local service Organisation is aware of your move and able to look after you and your appliances.

<b>France</b>	Senlis	+33 (0) 3 44 62 20 13
<b>Sweden</b>	Stockholm	+46 (0) 20 78 77 50
<b>Germany</b>	Nurnberg	+49 (0) 800 234 7378
<b>UK</b>	Slough	+44 (0) 1753 219898
<b>Italy</b>	Pordenone	+39 (0) 800 117511
<b>Ireland</b>	Dublin	+353 (0) 14090753

 **The Electrolux Group. The world's No.1 choice.**

*The Electrolux Group is the world's largest producer of powered appliances for kitchen, cleaning and outdoor use. More than 55 million Electrolux Group products (such as refrigerators, cookers, vacuum cleaners, chain saws and lawn mowers) are sold each year to a value of approx. 14 billion USD in more than 150 countries around the world.*

 **Electrolux**



- Before use
- Maintenance
- Installation

## Contents

<b>Before use</b>	2	External cleaning	5
Setting the water softener	2	Prolonged periods of non-operation	5
Filling with salt	2	Frost precautions	5
Filling with rinse aid and adjusting the dose	3	Moving the machine	5
Use of detergent	3	<b>Something not working</b>	6
<b>Hints and tips</b>	4	<b>Installation</b>	7
<b>Maintenance and cleaning</b>	5	Water supply connections	7
Internal cleaning	5	Water outlet connection	7
Cleaning the filters	5	Electrical connection	7

## Important safety information

It is most important that this instruction book should be retained with the appliance for future reference. Should the appliance be sold or transferred to another owner, or should you move house and leave the appliance, always ensure that the book is left with the appliance in order that the new owner can get to know the functioning of the appliance and the relevant safety information.

This information has been provided in the interest of your safety. You **MUST** read it carefully before installing or using the appliance.

### Installation

- This appliance is heavy. Care should be taken when moving it.
- It is dangerous to alter the specifications or attempt to modify this product in any way.
- Care must be taken to ensure that the appliance does not stand on the electrical supply cable.
- The appliance should not be connected to the electrical supply by means of an extension cable.
- Any electrical work required to install this appliance should be carried out by a qualified electrician or competent person.
- Any plumbing work required to install this appliance should be carried out by a qualified plumber or competent person.

### Child Safety

- This appliance is designed to be operated by adults. Children should not be allowed to tamper with the controls or play with the product.
- Keep all packaging well away from children.
- Keep all detergents in a safe place out of children's reach.

### During Use

- Items that are contaminated by petrol, paint, steel or iron debris, corrosive, acidic or alkaline chemicals must not be washed in this dishwasher.
- Under no circumstances should you open the door whilst the appliance is in operation. Always turn off the appliance before opening the door.
- Only use detergent specifically designed for use in dishwashers.

- Long bladed knives stored in an upright position are a potential hazard.
- Long and/or sharp items of cutlery such as carving knives must be positioned horizontally in the upper basket.
- When finishing loading or unloading close the door, as an open door can be a hazard.
- Do not sit or stand on the open door.
- Isolate the appliance from the power supply and turn off the water supply after use.
- Care should be taken when cleaning the bottom door seal and hinge area as any exposed metal edges may cut if care is not taken.
- This product should be serviced by an authorised Service engineer, and only genuine spare parts should be used.
- Under no circumstances should you attempt to repair the machine yourself. Repairs carried out by inexperienced persons may cause injury or serious malfunctioning. Contact your local Service Force Centre. Always insist on genuine spare parts.

### Conservation

**In the interest of the environment:**

- Materials marked with the symbol  are recyclable.
- Check with your local Council or Environmental Health Office to see if there are facilities in your area for re-cycling this appliance.
- When the appliance is to be scrapped, cut off the power supply cable and make the door closing device unusable to prevent young children from being trapped inside.
- Help to keep your country tidy - use authorised disposal sites for your old appliance.

# Before use

## Before using your dishwasher for the first time:

1. Ensure that the electrical and water connections comply with the installation instructions
2. Remove all packaging from inside the appliance
3. Set the water softener
4. Pour 1 litre of water inside the salt container and then fill with salt
5. Fill the rinse aid dispenser.

## Setting the water softener

The dishwasher is equipped with a water softener designed to remove minerals and salts from the water supply, which would have a detrimental or adverse effect on the operation of the appliance.

The higher the content of these salts, the harder your water is. Water hardness is measured in equivalent scales, Clarke, French degrees and PPM (parts per Million).

The softener should be adjusted according to the hardness of the water in your area. Your local Water Authority can advise you on the hardness of the water in your area.

The dishwasher is factory set at level 2.

If this level is not suitable for your area the softener should be adjusted.

**If your water is level 1 it is already soft and therefore there is no need to use salt.**

**In this case adjust the water softener on level 1 without using salt.**

### **Only for dishwasher models with salt refill indicator light:**

*if the water softener has been adjusted on level 1 without use of salt, the salt refill indicator light on the control panel will always remain illuminated when the machine is switched on.*

**To adjust the water softener, follow the instructions given in the chart**

Level	Water hardness			Use of salt	Water softener adjustment	Adjustment on the machine	
	French degrees (°TH)	Clarke degrees	PPM (parts per million)			A*	B
1	0 - 14	0 - 10	0 - 140	NO	-	NO	1
2	15 - 39	11 - 27	141 - 390	YES	-	NO	1
3	40 - 50	28 - 35	391 - 500	YES	+	NO	1
4	51 - 70	36 - 49	501 - 700	YES	-	YES	2
5	71 - 90	50 - 63	701 - 900	YES	+	YES	2

\* If your appliance is type A and adjustment is necessary, YES in the water softener chart indicates that the membrane must be pierced as shown.

### Water softener adjustment

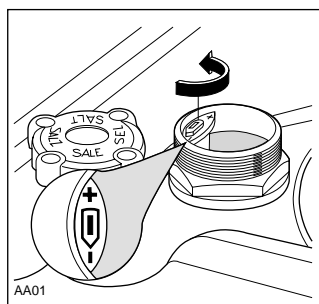

### Adjustment on the machine

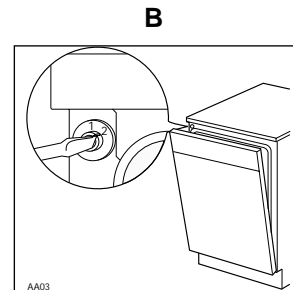
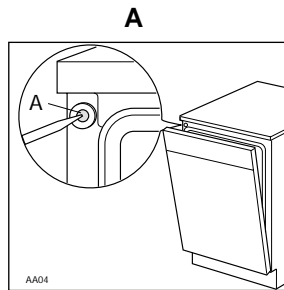

## Filling with salt

### Attention!

**Only use salt specifically designed for use in dishwashers.**

**All other types of salt not specifically designed for use in dishwasher, especially table salt, will damage the water softener.**

**Only fill with salt just before starting a washing programme. This will prevent any grains of salt or salty water, which may have been spilled, remaining on the bottom of the machine, which may cause corrosion.**

### To fill:

1. To fill with salt, unscrew the cap of the salt container.
2. Pour 1 litre of water inside the container (**this is necessary only before filling with salt for the first time**).
3. Using the funnel (if provided), pour in the salt until the container is full. Do not worry if water overflows from the unit when filling with salt, this is quite normal.
4. Replace the cap making sure that there is no trace of salt on the screw thread or on the gasket.
5. Screw on the cap tightly.

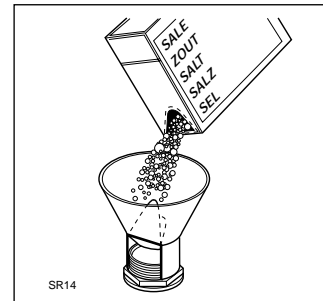

The salt container will require topping up periodically. According to the model, an indicator reminds you when filling with salt:

- A)** The salt cap has a refill indicator window in the centre. A green float is clearly visible when there is salt inside the container, and almost disappears when the salt has finished reminding you to add salt.

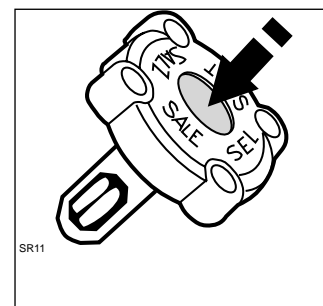

- B)** A salt indicator light on the control panel will come on when the salt has finished.

**The salt indicator light on the control panel can remain illuminated for 2-6 hours after the salt has been replenished, assuming the dishwasher remains switched on. If you are using salts that take longer to dissolve then this can take longer.**

**The function of the machine is not affected.**

## Rinse aid

Rinse aid is automatically added during the last rinse, ensuring thorough rinsing, and spot and streak free drying. The dispenser, which is positioned inside the door, holds about 110 ml of rinse aid, which is sufficient for 16 - 40 dishwashing programmes, depending upon the dosage setting.

## Filling with rinse aid

1. Open the container by turning the lid (A) anticlockwise.
2. Add the rinse aid until the container is completely full. The indicator (B) will be completely dark.

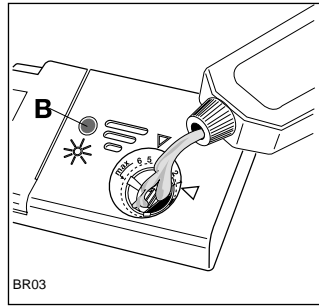
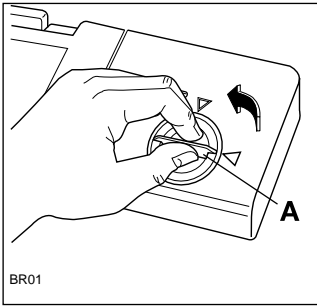

3. Top up the rinse aid when the indicator (B) becomes clear.  
**(Only for models with rinse aid indicator light)**  
Top up with rinse aid when the rinse aid indicator light on the control panel illuminates.

**Ensure that the lid is closed after every refill.**

Do not put liquid detergent in the rinse aid compartment. Clean up any rinse aid spilt during filling with an absorbent cloth to avoid excess foaming during the next wash.

## Adjusting the dose

According to the finish and drying results obtained, adjust the dose of rinse aid by means of the 6 position selector (C) (position 1 minimum dosage, position 6 maximum dosage).

Increase the dose if there are drops of water or lime spots on the dishes after washing.

Reduce it if there are sticky whitish streaks on the dishes.

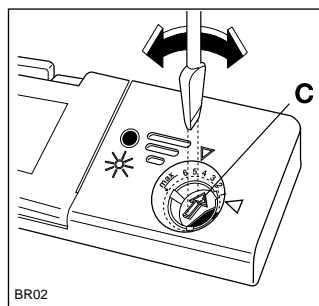

## Use of detergent

**Only use detergents specifically designed for use in dishwashers.**

We recommend the use of **Finish** detergents which are available in the following options:

**Finish Double Action Tablets.** Each tablet has the exact amount of detergent required, simply place in the dispenser.  
**Finish Powder** recommended for every day use.

**Finish Liquid Gel** ideal for every day use. As the gel is extra gentle it is recommended for fine bone china.

## If using powder detergents proceed as follows:

1. Open the dispenser lid by pulling the catch (D).
2. Add the detergent according to the recommended quantity given in the "Washing programmes" chart (see "Instruction Book - Part 2").  
As all detergents are not the same, you should also consult the instructions on the packet.
3. Always close the lid.
4. If the programme has a prewash add a little amount of detergent over the lid of the dispenser. Follow the recommended quantity given in the "Washing programmes" chart (see "Instruction Book - Part 2").

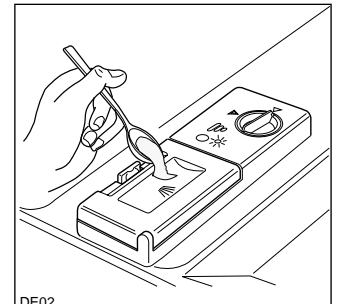
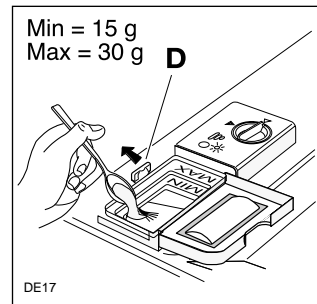

## If using detergent in tablets proceed as follows:

1. For all programmes; place 1 tablet inside the detergent dispenser.
2. Always close the lid.
3. For all programmes with prewash; place a portion of a further tablet on the lid of the detergent dispenser.

**If your dishwasher has a SID dispenser and you require a prewash, put the extra detergent into the SID dispenser and not on the lid of the detergent dispenser.**

**Insufficient quantities of detergent will produce poor washing results, whereas an excessive amount of detergent will not improve washing results and is also wasteful.**

**Using no more than the correct amount also contributes to reducing pollution.**

## Compact detergents with enzymes

In these compact powders the environmentally unfriendly components have been replaced by natural enzymes and other more biodegradable substances.

The enzymes deploy their full dirt dissolving power at a temperature as low as 50°C.

By choosing the 50°C programmes (**if available**) you can therefore achieve the same cleaning results that would otherwise be achievable only with 65°C programmes and conventional detergents. These new compact powders are generally phosphate-free.

# Hints and tips

## To save energy

Place dishes in the machine immediately after every meal and wait until the dishwasher is full before washing.

If necessary run the Rinse and Hold programme (see "Washing Programmes" chart) so that any food scraps do not become caked on the dishes while you are waiting to run the complete wash programme.

Do not prewash dishes under running water.

## For best washing and drying results

Before loading, remove all scraps of food and soak very heavily soiled pots and pans.

Arrange saucepans, cups and glasses etc. upside-down.

Tilt items with convex or concave surfaces so that the water drains off easily.

Avoid contact between the dishes as far as possible.

## Items not suitable for dishwashers

**The following items should not be washed in the dishwasher (unless they are sold as dishwasher proof):**

- Cutlery with wooden or horn handles or glued parts
- bronze cutlery
- saucepans with wooden handles
- aluminium ware
- crystal ware
- leaded glass
- plastic items
- antique or fine decorated china

Certain types of decoration can discolour when washed in a dishwasher.

Crystal-ware and plastic objects, if not guaranteed dishwasher proof should be washed by hand.

Certain types of glass can also become opaque after being washed several times in a dishwasher.

A chemical reaction can occur between silver cutlery and stainless steel cutlery. As a precaution, do not wash together.

Iron and cast iron objects can rust and stain other items.

Aluminium tends to go black, copper, pewter and brass tend to stain.

**If in doubt check with manufacturer of the item.**

**When buying new dishes, ensure that they are dishwasher proof.**

**For best results we recommend the use of Finish detergents, rinse aid and salt.**



# Maintenance and cleaning

## Internal cleaning

Ensure that the seals around the door, the detergent and rinse aid dispensers are cleaned regularly with a damp cloth.

We recommend the use of **Finish Dishwasher Cleaner** every 3 months or run a 65°C wash without dishes using detergent.

Regular use of **Finish Dishwasher Cleaner** cleans inaccessible parts, eliminates unpleasant food odours and helps prevent the build-up of limescale.

## Cleaning the central filter

(After each wash)

Inspect the central filters (B) and (C) and remove any scraps of food with a brush, under running water.

Filters (B) and (C) are both removed by lifting up the outer one (B) (pulling the central funnel upwards); the smaller filter (C) can be removed by pressing the two tongues (D).

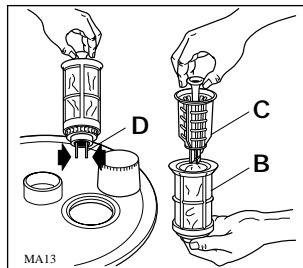
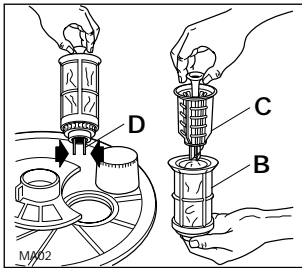

Once cleaned, refit the filters by pressing them down until they click into place.

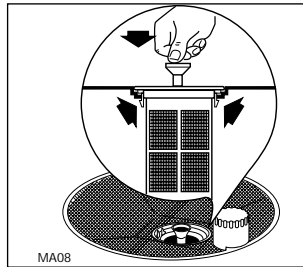

## Cleaning the large filter

(Every week)

Clean the large filter (A) on both sides under running water, using a brush.

To take it out, remove the spray arm by pressing the two tongues (E), turn the ring (F) anticlockwise and then slide the whole part out. Refit the filter following the above instructions in reverse order.

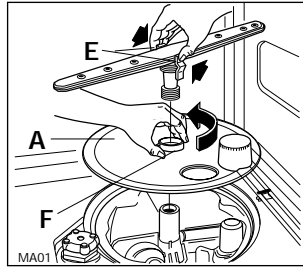
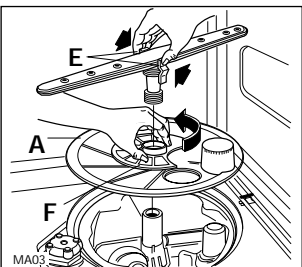

**The dishwasher must not be used without filters. Incorrect repositioning and fitting of the filters will produce poor washing results. Cleaning the filters is vital to ensure correct operation of the machine.**

## External cleaning

Clean the external surfaces of the machine and control panel with a damp soft cloth. If necessary use only neutral detergents. Never use abrasive products, scouring pads or solvent (acetone, trichloroethylene etc....).

## Prolonged periods of non-operation

If you are not using the machine for any period of time you are advised to:

1. Unplug the appliance and then turn off the water.
2. Fill the rinse aid dispenser.
3. Leave the door ajar to prevent the formation of any unpleasant smells.
4. Leave the inside of the machine clean.

## Frost precautions

Avoid placing the machine in a location where the temperature is below 0°C. If this is unavoidable, empty the machine, close the appliance door, disconnect the water inlet pipe and empty it.

## Moving the machine

If you have to move the machine (moving house etc...):

1. Unplug it.
2. Turn the water tap off.
3. Remove the water inlet and discharge hoses.
4. Pull the machine out together with the hoses.

Avoid over tilting the machine during transportation.

# Something not working

Certain problems are due to lack of simple maintenance or oversights, which can be solved easily without calling out an engineer. Before contacting your local Service Force Centre, please carry out the checks listed below.

**Important:** If you call out an engineer to a fault listed below or to repair a fault caused by incorrect use or installation a charge will be made even if the appliance is in guarantee.

Symptom	Solution
The machine will not start	<ul style="list-style-type: none"> <li>● The door has not been properly closed.</li> <li>● The plug is not properly inserted in the power socket.</li> <li>● There is a power failure.</li> </ul>
The machine does not fill with water	<ul style="list-style-type: none"> <li>● Ensure the water tap is open.</li> <li>● Ensure the mains water supply has not been cut off.</li> <li>● The inlet hose may be squashed or bent. Reposition the hose.</li> <li>● The inlet hose may be blocked. Switch off the water supply and clean the filter.</li> </ul>
The filters are blocked	<ul style="list-style-type: none"> <li>● Clean the filters (refer to "Maintenance and cleaning").</li> </ul>
The spray arms are not rotating	<ul style="list-style-type: none"> <li>● Ensure the crockery is loaded correctly.</li> </ul>
The dishwasher will not drain	<ul style="list-style-type: none"> <li>● The drain hose may be squashed or bent. Reposition the hose.</li> <li>● The sink may be blocked. Clear any blockages.</li> <li>● The drain hose extension is not correct. Follow the instructions for connecting to the waste.</li> <li>● There is no vent in the end of the drain hose.</li> </ul>
The machine is noisy	<ul style="list-style-type: none"> <li>● Dishes are rattling against each other, refer to "Loading your machine".</li> <li>● The spray arms are knocking against the dishes. Refer to "Loading your machine".</li> </ul>
The door is difficult to close	<ul style="list-style-type: none"> <li>● The dishwasher is not level, or not properly built-in.</li> </ul>
Visible lime deposits or white film on the dishes	<ul style="list-style-type: none"> <li>● Check that there is salt and that the salt cap is tight.</li> <li>● Check that the right level of the water softener is set.</li> </ul>
The dishes are not quite dry	<ul style="list-style-type: none"> <li>● The rinse aid has run out or too little is being used.</li> </ul>
The dishes are not clean (poor wash)	<ul style="list-style-type: none"> <li>● The baskets are too full.</li> <li>● The dishes have not been arranged properly.</li> <li>● The spray arms do not rotate</li> <li>● The spray arms are clogged.</li> <li>● The filters are clogged.</li> <li>● The filters are not in the correct position.</li> <li>● Not enough detergent has been used or it is unsuitable.</li> <li>● The detergent is old or has gone hard.</li> <li>● The salt container cap is not properly closed.</li> <li>● The washing programme selected is too gentle.</li> </ul>

If after all these checks, the problem persists, contact your local Service Force Centre, quoting the model and serial number. This information can be found on the rating plate located on the right hand side of the dishwasher door.

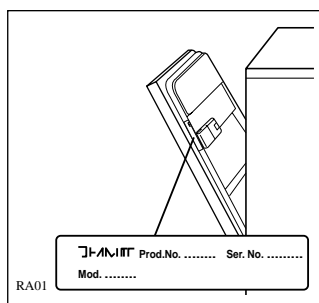

**This product should be serviced by an authorised Service engineer, and only genuine spare parts should be used. Under no circumstances should you attempt to repair the machine yourself. Repairs carried out by inexperienced persons may cause injury or serious malfunctioning. Contact your local Service Force Centre. Always insist on genuine spare parts.**

# Installation

Any electrical work required to install this appliance should be carried out by a qualified electrician or competent person.

Any plumbing work required to install this appliance should be carried out by a qualified plumber or competent person.

Remove all packaging before positioning the machine.

If possible, position the machine next to a water tap and a drain.

## Levelling

Good levelling is essential for correct closure and sealing of the door. When the appliance is correctly levelled, the door will not catch on the levelling spacers on either side of the cabinet. If the door does not close correctly, loosen or tighten the adjustable feet until the machine is perfectly level.

## Water supply connections

This dishwasher must be plumbed into a cold water supply. The water pressure must be within the limits given in the "Technical specifications" (Instruction Book - Part 2).

Your local Water Authority will advise you on the average mains pressure in your area.

The dishwasher features fill and drain hoses which can be turned either to the left or the right to suit the installation.

**Do not use, for connection, old hoses which have been used in another appliance.**

**The locknut must be correctly fitted to avoid water leaks.**

Avoid bends or kinks in the hose which could prevent or slow down the water supply.

If the machine is connected to new pipes or pipes which have not been used for a long time, you should run the water for a few minutes before connecting the inlet hose. This will prevent deposits of sand or rust clogging the inlet hose.

## Water outlet hose connection

The end of the drain hose can be connected in the following ways:

1. To the sink outlet spigot, securing it to the underside of the work surface. This will prevent waste water from the sink running into the machine.
2. Hooked over the edge of the sink using the special curved plastic guide (if provided).
3. To a stand pipe provided with vent-hole, minimum internal diameter 4 cm.

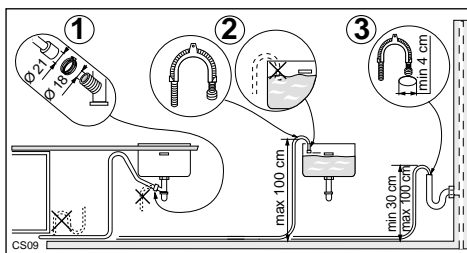

The waste connection must be at a height of between 30 cm (minimum) and 100 cm (maximum) from the bottom of the dishwasher.

The drain hose can face either to the right or left of the dishwasher

Ensure the hose is not bent or squashed as this could prevent or slow down the discharge of water.

If you use a drain hose extension it must be no longer than 2 metres and its internal diameter must be no smaller than the diameter of the hose provided.

Likewise the internal diameter of the couplings used for connections to the waste outlet must be no smaller than the diameter of the hose provided.

The sink plug must not be in place when the machine is draining as this could cause the water to siphon back into the machine.

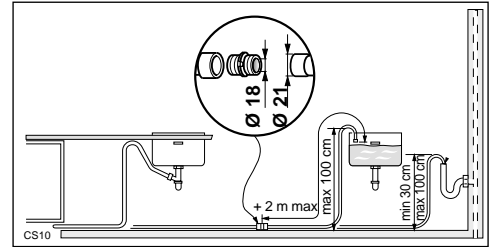

### Attention!

**Our appliances are supplied with a security device to protect against the return of dirty water back into the machine.**

**If the spigot of your sink has a "no return valve" incorporated this can prevent the correct draining of your dishwasher. We advise you therefore to remove it.**

## Electrical connection

**This appliance must be earthed.**

**The manufacturer declines any responsibility should this safety measure not be observed.**

**The appliance should not be connected to the electrical supply by means of an extension cable.**

If the plug that is fitted to your appliance is not suitable for the socket, it must be cut off and the appropriate plug fitted.

### Important

The wires on the mains lead are coloured in accordance with the following code:

- Green and Yellow** - Earth
- Blue** - Neutral
- Brown** - Live

If you fit your own plug, the colours of the wires in the mains lead of your appliance may not correspond with the markings identifying the terminals in your plug.

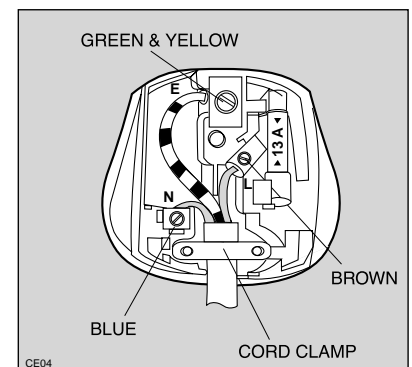

### Proceed as follows:

1. Connect the Green and Yellow (earth) wire to the terminal in the plug which is marked with the letter "E" or the earth symbol  $\oplus$  or coloured green and yellow.
2. Connect the Blue (neutral) wire to the terminal in the plug which is marked with the letter "N" or coloured black.
3. Connect the Brown (live) wire to the terminal in the plug which is marked with the letter "L" or coloured red.

The plug moulded onto the lead incorporates a 13amp BSI362 fuse. Only ASTA or BSI fuses should be used.

The plug must not be used if the fuse cover/carrier is lost. The cover/carrier is indicated by the coloured insert at the base of the plug.

A replacement cover/carrier must be obtained from your local Service Force Centre.

**This appliance complies with the following E.E.C. Directives:**

- 73/23 or 19.2.73 (Low Voltage Directive) and subsequent modifications;
- 89/336 or 3.5.89 (Electromagnetic Compatibility Directive) and subsequent modifications.